

Vent-A-Hood®



ELECTRICAL AND DUCTING SPECIFICATIONS

STANDARD BLOWER PLACEMENTS

SLH6-K UNDER-CABINET HOOD

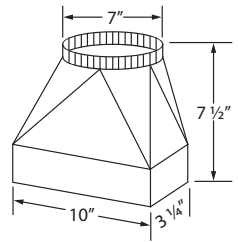
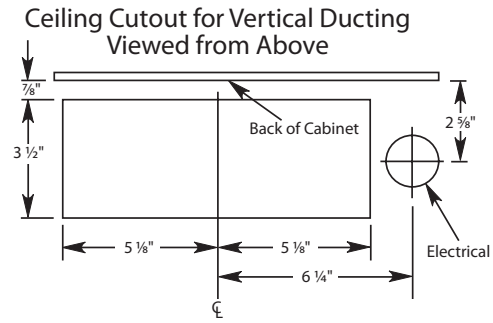
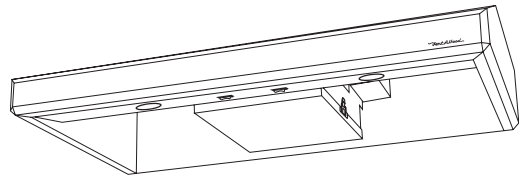

Optional VP521 transition is available for top-venting applications

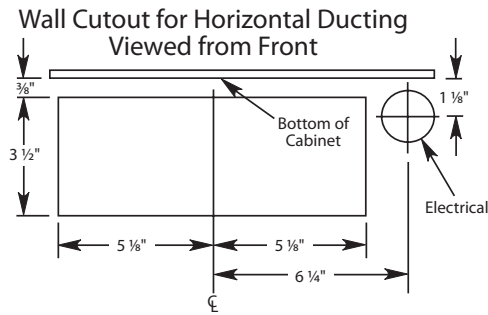

KHSLD LINER INSERT

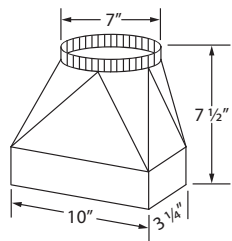
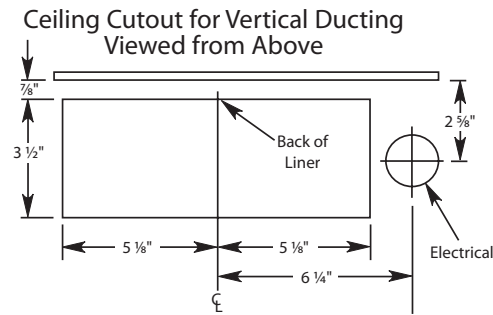
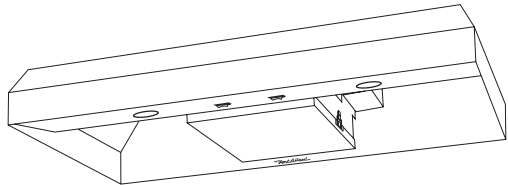

Optional VP521 transition is available for top-venting applications

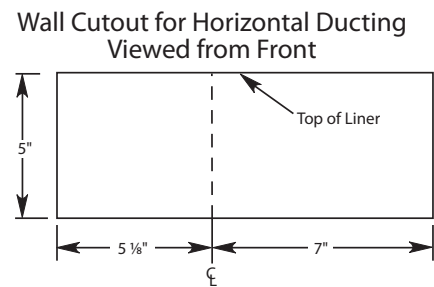

STANDARD BLOWER PLACEMENTS

UNDER CABINET, WALL MOUNT, AND WALL MOUNT LINER INSERTS

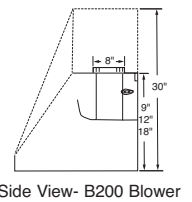
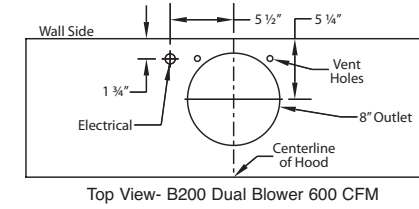
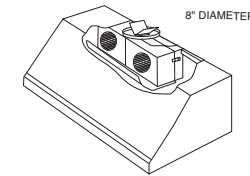
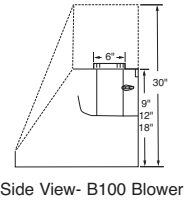
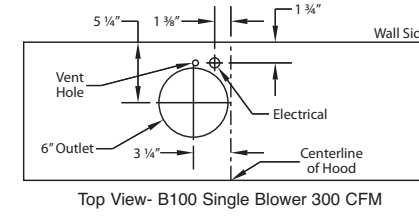
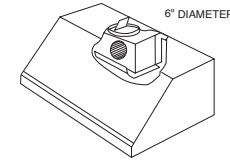

For hoods wider than 66", consult the factory for blower outlet locations

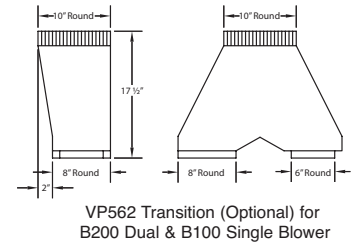
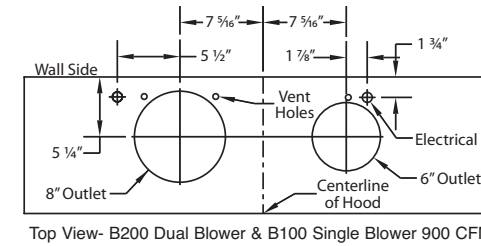
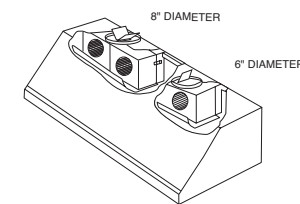

For hoods wider than 66", consult the factory for blower outlet locations

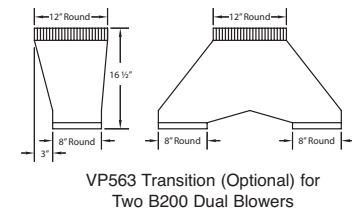
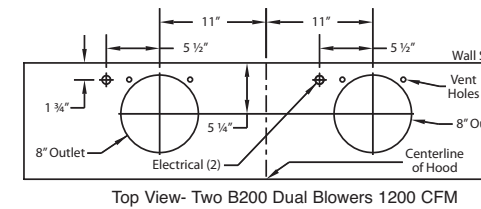
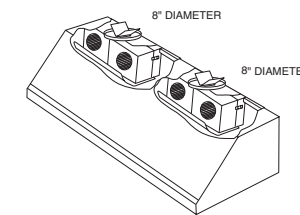

STANDARD BLOWER PLACEMENTS

EURO-STYLE WALL MOUNT HOODS

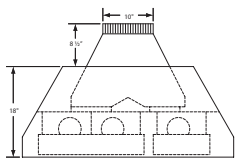
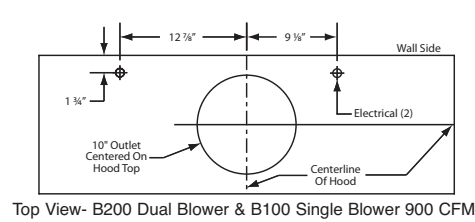
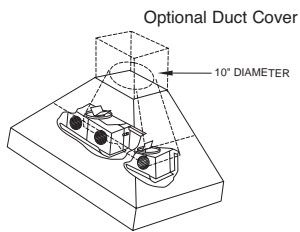
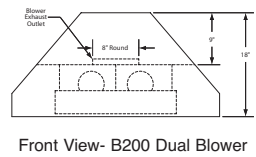
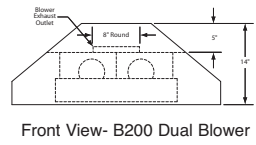
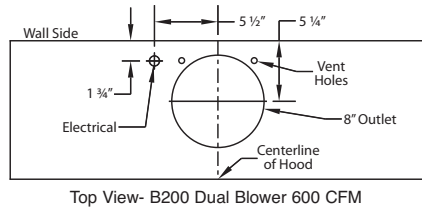
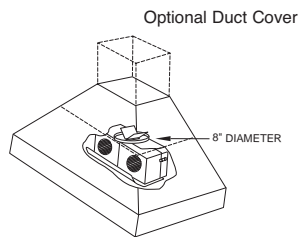
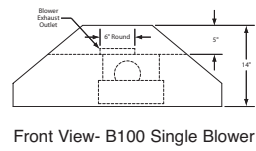
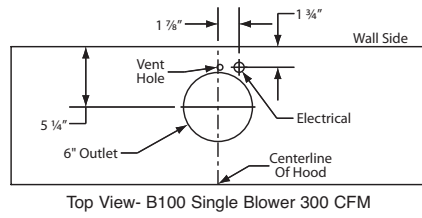
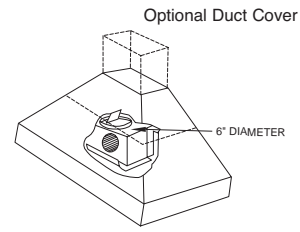

Front View- VP562 Standard Transition (Included)

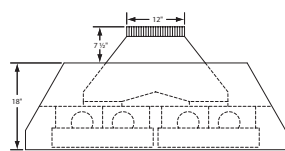
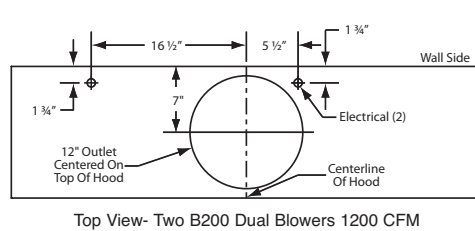
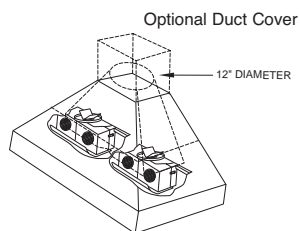

Front View- VP563 Standard Transition (Included)

STANDARD BLOWER PLACEMENTS

CONTEMPORARY WALL MOUNT HOODS

GTH

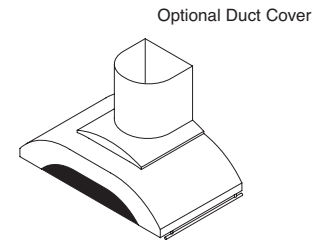

Ceiling Cutout for Vertical Ducting Viewed from Above

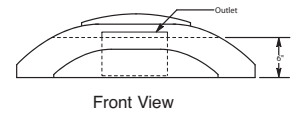
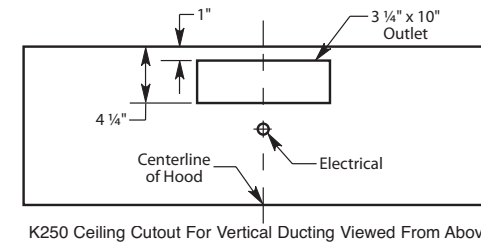

Wall Cutout For Horizontal Ducting Viewed From Front

(Requires VP559 Back Vent Elbow, Sold Separately)

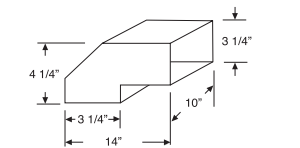
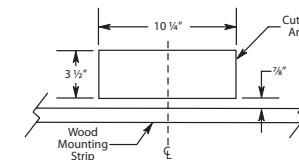

Optional VP559 back vent elbow is available for back vent applications

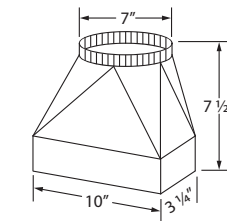

Optional VP521 transition is available for top-venting applications

ZTH

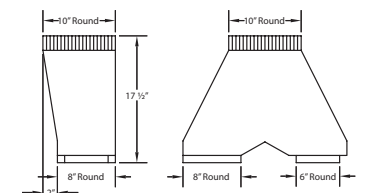
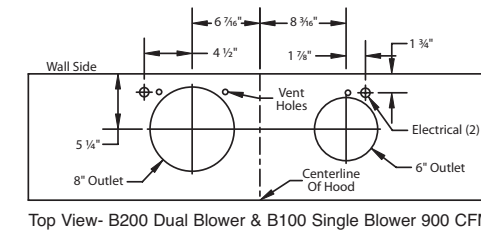
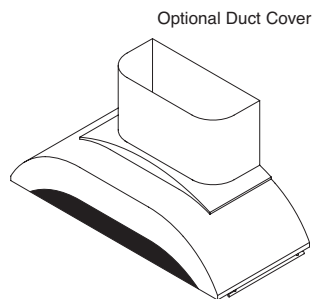
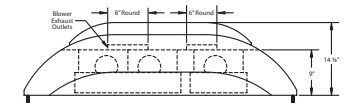
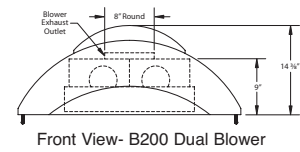
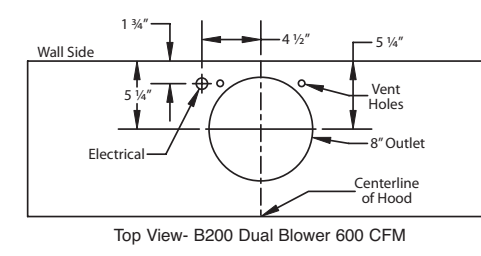
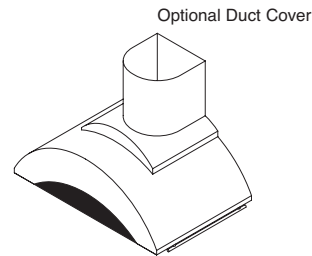

STANDARD BLOWER PLACEMENTS

CONTEMPORARY WALL MOUNT HOODS

CWLH9

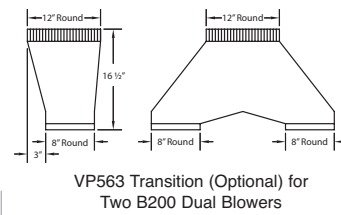
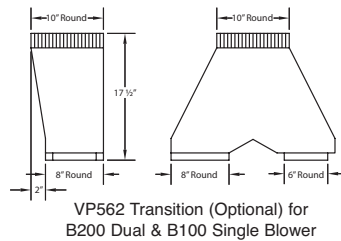
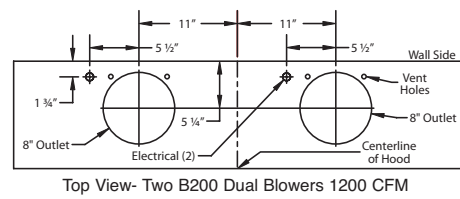
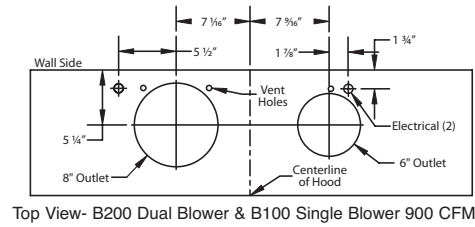
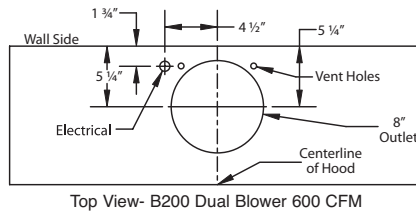
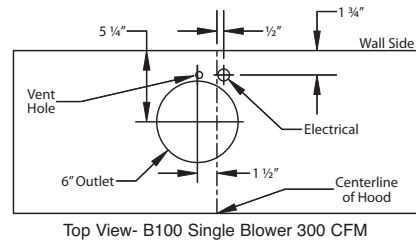
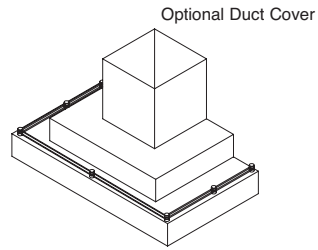

STANDARD BLOWER PLACEMENTS

12" AND 18" ISLAND HOODS AND LINER INSERTS

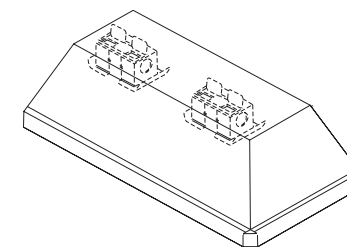
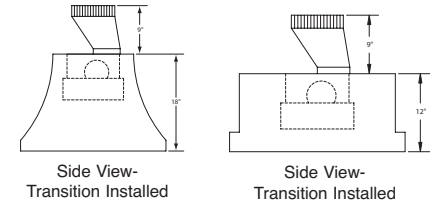
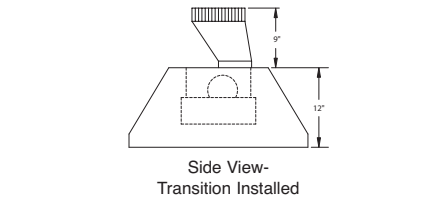
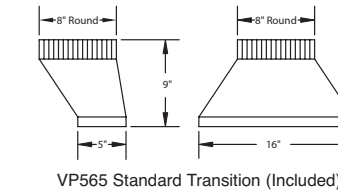
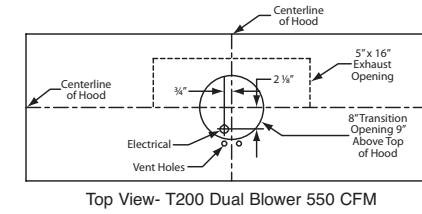
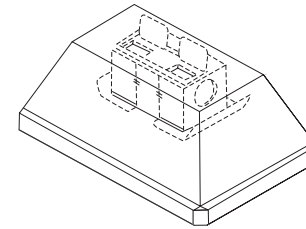

On selected models, hoods wider than 66" may be ordered with additional halogen lighting between the blowers

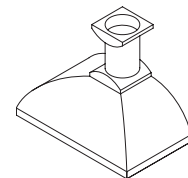
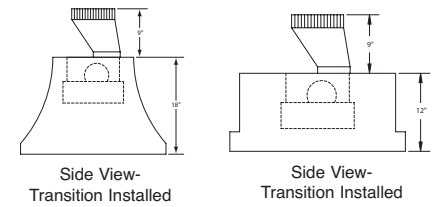
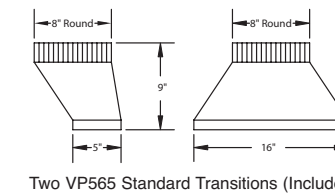
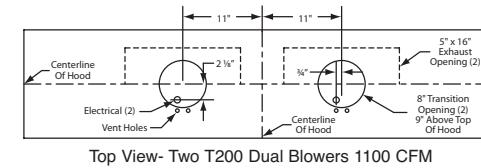

XLH12 WITH OPTIONAL ROUND DUCT COLLARS AND FINISHED ROUND DUCT

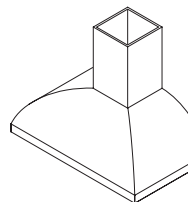

XLH12 WITH OPTIONAL 10" X 10" DUCT COVER

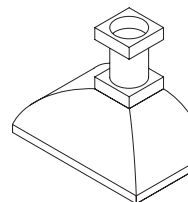

XLH12 WITH OPTIONAL SQUARE DUCT COLLARS AND FINISHED ROUND DUCT

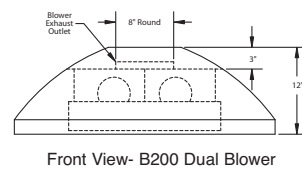
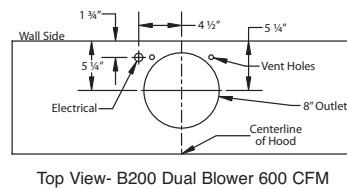

Wall Cutout For Horizontal Ducting Viewed From Front (Requires VP561 Back Vent Elbow, Sold Separately)

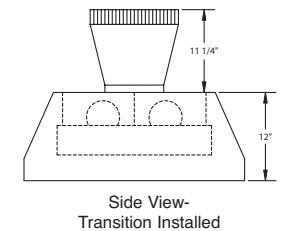
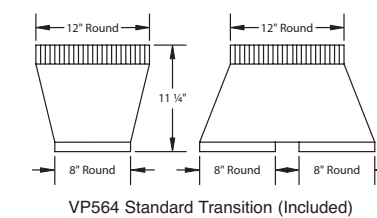
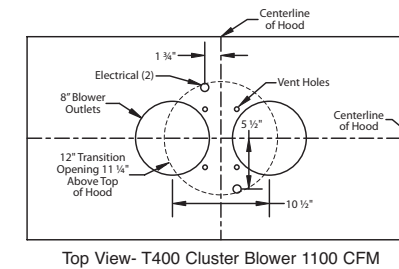
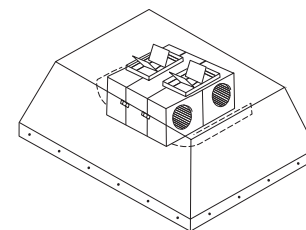
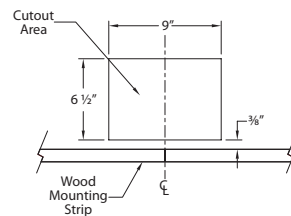

30" TALL ISLAND HOODS

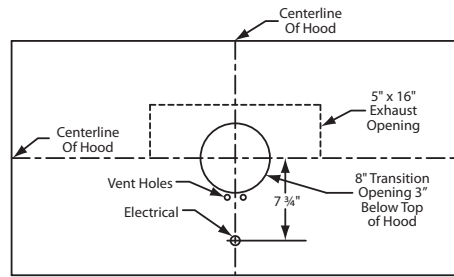
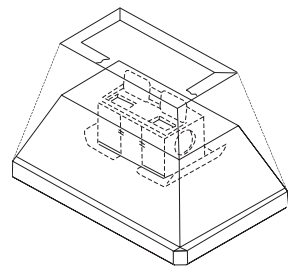

Top View- T200 Dual Blower 550 CFM

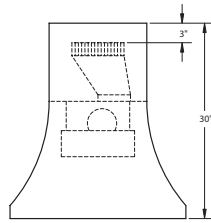

Side View- Transition Installed

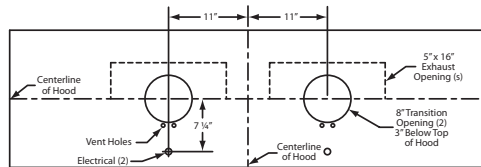
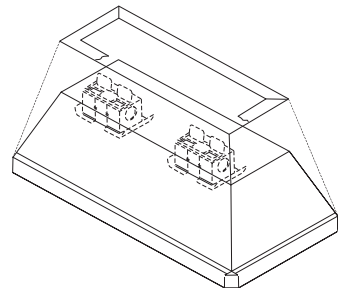

Top View- Two T200 Dual Blowers 1100 CFM

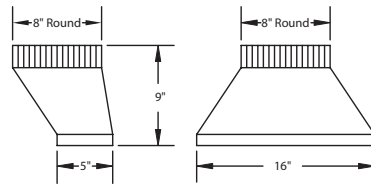

T200 Dual Blower Includes One VP565 Standard Transition.

Two T200 Dual Blowers Includes Two VP565 Standard Transitions

WHAT MAKES A VENT-A-HOOD® A VENT-A-HOOD®?

QUIET.
TURN ON A VENT-A-HOOD® RANGE HOOD, AND YOU'LL HEAR ONLY A WHISPER OF AIR MOVEMENT, BECAUSE THE MAGIC LUNG® BLOWER SYSTEM PROVIDES THE QUIETEST VENTILATION AVAILABLE. UNBIASED TESTS SHOW THAT THE MAGIC LUNG® BLOWER HAS ONE OF THE LOWEST SOUND RATINGS IN THE INDUSTRY – ESPECIALLY AT HIGH SPEED – WHERE IT COUNTS.

EFFICIENT.
THE POWERFUL MAGIC LUNG® BLOWER TRAPS COOKING CONTAMINANTS, LIQUIFIES GREASE VAPOR AND REMOVES HEAT POLLUTED AIR. IT COMBINES SUFFICIENT AIR PRESSURE AND CONSTANT SPEED CENTRIFUGAL FILTRATION – AND BECAUSE IT DOESN'T PULL AIR THROUGH A FILTER – IT PROVIDES THE MOST EFFICIENT KITCHEN VENTILATION AVAILABLE TODAY. THIS FILTRATION SYSTEM, ALONG WITH THE OPEN CANOPY DESIGN OF A VENT-A-HOOD®, DELIVERS PERFORMANCE FAR MORE EFFICIENTLY THAN OTHER FILTRATION SYSTEMS.

EASY-CLEANING.
THE MAGIC LUNG® BLOWER HOUSING SNAPS APART FOR EASY CLEANING IN THE DISHWASHER OR WITH WARM SOAPY WATER. THE MAGIC LUNG® MOTOR IS ALSO ENCLOSED IN A SPECIALLY DESIGNED HOUSING TO KEEP IT OUT OF THE GREASE FLOW, THEREBY MAXIMIZING ITS OPERATIONAL PERFORMANCE. EASY TO SNAP-APART HOUSINGS AND FULLY ENCLOSED MOTORS MEAN NO HIDDEN GREASE IN HARD TO REACH AREAS BEHIND A MESH OR BAFFLE FILTER AS WITH OTHER BRANDS IN THE MARKETPLACE.

FIRE-SAFETY.
THE MAGIC LUNG® CONSTANT SPEED CENTRIFUGAL BLOWER IS DESIGNED TO LIQUEFY GREASE IN THE SEALED BLOWER HOUSING AND TO CREATE A PRESSURE BARRIER, LOWERING THE RISK OF AN ATTIC OR WALL FIRE. IN 70+ YEARS OF MANUFACTURING THIS SYSTEM, VENT-A-HOOD® HAS NEVER RECEIVED A REPORT OF AN ATTIC OR WALL FIRE WHEN THE MAGIC LUNG® HAS BEEN IN USE.

POWERFUL.
MAGIC LUNG® BLOWERS CAN BE CONFIGURED TO PROVIDE THE POWER YOU NEED FOR EVEN THE MOST DEMANDING COOKING SURFACE. EACH HIGHLY EFFICIENT MAGIC LUNG® BLOWER SUPPLIES 300 CFM OF AIR MOVEMENT; YOU CAN COMBINE MULTIPLE BLOWERS IN A SINGLE VENT-A-HOOD® RANGE HOOD TO CREATE THE PERFECT VENTILATION FOR YOUR COOKING SURFACE.

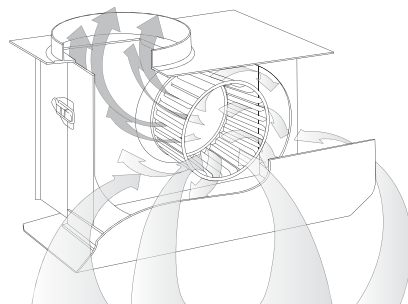

EURO-STYLE ISLAND HOODS

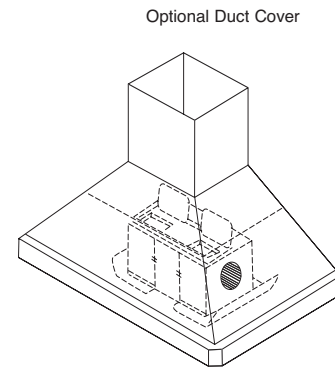

Optional Duct Cover

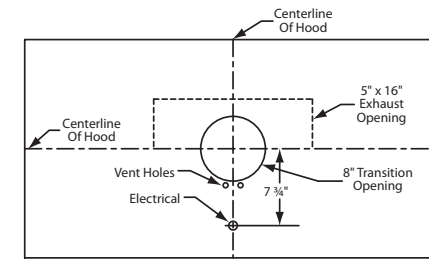

Top View- T200 Dual Blower 550 CFM

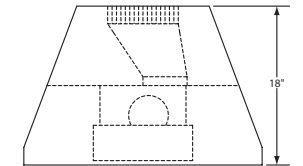

Side View- Transition Installed

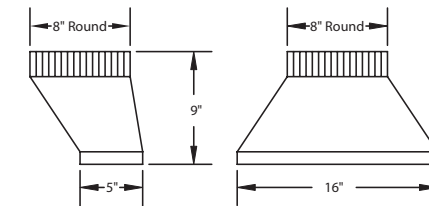

VP565 Standard Transition (Included)

CONTEMPORARY ISLAND HOODS

CILH₉

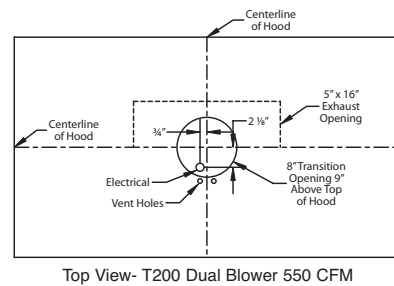
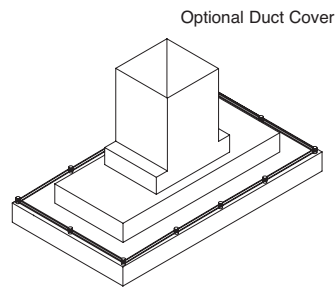

Top View- T200 Dual Blower 550 CFM

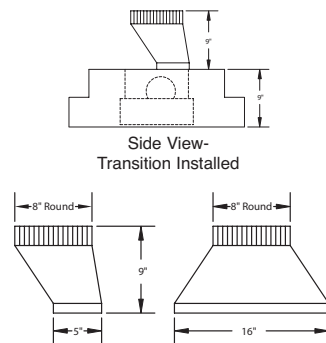

VP565 Standard Transition (Included)

CILH₉

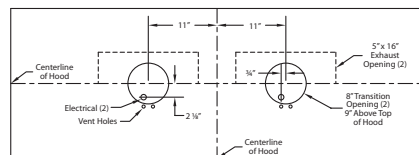
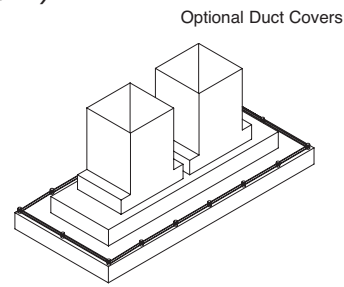

Top View- Two T200 Dual Blowers 1100 CFM

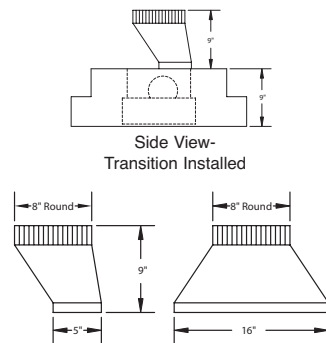

Two VP565 Standard Transitions (Included)

IZTH

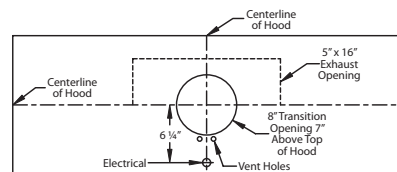
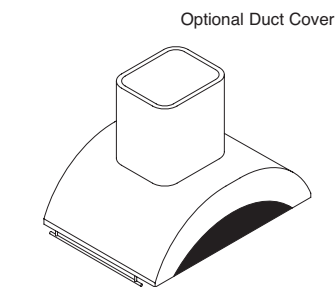

Top View- T200 Dual Blower 550 CFM

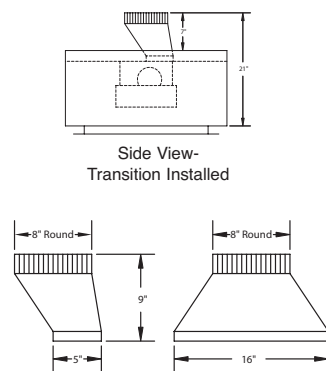

VP565 Standard Transition (Included)

IZTH

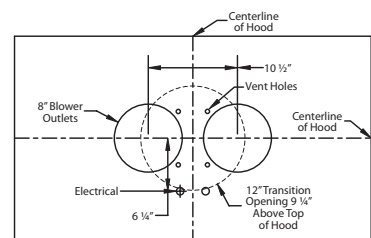
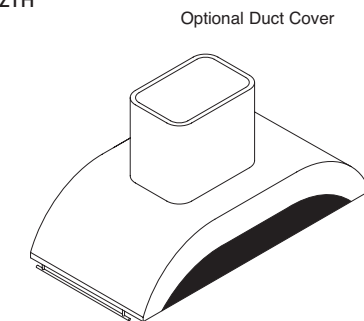

Top View- T400 Cluster Blower 1100 CFM

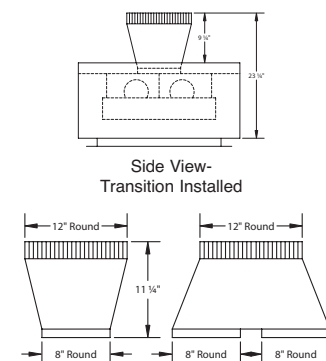

VP564 Standard Transition (Included)

Model	Volts	Amps*	RPM	CFM SP@0.0"†	Equivalent CFM‡	CFM SP@0.1"	CFM SP@0.2"	CFM SP@0.3"	Minimum Round Duct Size	Sones§
B100	115	1.5	1550	300	450	273	245	225	6" (28 in ²)	5.4
B200	115	2.9	1550	600	900	531	480	430	8" (50 in ²)	6.5
B200 Dual & B100 Single	115	4.4	1550	900	1350	804	725	655	10" (79 in ²)	6.3
Two B200 Duals	115	5.8	1550	1200	1800	1062	960	860	12" (113 in ²)	6.6
K250 (Top Vent)	115	2.2	1550	250	375	223	220	190	7" (38 in ²)	7.4
K250 (Back Vent)	115	2.2	1550	220	330	215	195	180	7" (38 in ²)	7.4
T200 Dual	115	2.9	1550	550	900	507	471	431	8" (50 in ²)	6.0
T400 Cluster	115	5.8	1550	1100	1800	998	855	774	12" (113 in ²)	6.4
RM1000 Remote	115	3.2	1100	945	N/A	922	884	852	10" (79 in ²)	N/A
RM1500 Remote	115	5.0	1130	1500	N/A	1455	1410	1375	10" (79 in ²)	N/A

* ADD 2.5 AMPS FOR EACH WARMING LAMP AND 0.5 ADDITIONAL AMP FOR EACH HALOGEN LIGHT BULB. IN GENERAL, THERE WILL BE ONE HALOGEN LIGHT FOR EVERY 14" OF HOOD WIDTH, EVENLY SPACED ALONG THE LIGHT BOX. ISLAND HOODS WILL HAVE FOUR HALOGEN LIGHTS, ONE IN EACH CORNER. MODEL GTH HAS TWO HALOGEN LIGHTS, ONE ON EACH SIDE. MODEL ZTH HAS FOUR HALOGEN LIGHTS, TWO ON EACH SIDE. HOODS EQUIPPED WITH FLUORESCENT LIGHTING WILL HAVE ONE LIGHT FIXTURE PER BLOWER UNIT EXCEPT FOR ISLAND HOODS, WHICH HAVE TWO (ON THE FRONT AND BACK OF THE HOOD).

† CFM RATING IS BASED ON 0.0 INCHES STATIC PRESSURE (RESISTANCE IN THE DUCTING, TURNS, ROOF CAPS, ETC.) CFM RATING WILL CHANGE AS STATIC PRESSURE IS INCREASED. STATIC PRESSURE INCREASES BECAUSE OF DUCTING AND LENGTH OF DUCT RUN.

‡ EQUIVALENT CFM REFERS TO THE FACT THAT THE MAGIC LUNG® USES CENTRIFUGAL FILTRATION UNITS, WHEREAS OTHERS USE CONVENTIONAL FILTERS. APPLY THIS GUIDELINE WHEN COMPARING BLOWER UNITS MADE BY OTHER MANUFACTURERS.

§ RATINGS IN ACCORDANCE WITH THE STANDARD TEST CODE BY THE ENERGY SYSTEMS LABORATORY OF THE TEXAS ENGINEERING EXPERIMENT STATION. ALL TESTS WERE MEASURED AT FULL SPEED TO DEMONSTRATE THE MOST ACCURATE SOUND RATING (OTHER MANUFACTURERS MAY USE LOWER SPEEDS FOR TESTING WHICH DON'T REFLECT ACCURATE OPERATING SOUND LEVELS).

DUCTING Do's AND DON'TS

NEVER RESTRICT THE DUCT SIZE. WHEN COMBINING DUCTS TOGETHER, THE SQUARE INCH AREA MUST REFLECT THE TOTAL SQUARE INCH AREA OF THE DUCTS BEING COMBINED. USING VENT-A-HOOD TRANSITIONS (WHERE APPLICABLE) WILL ENSURE PROPER EFFICIENCY.

BLOWER	DUCT SIZE	SQ. INCH AREA	VENT-A-HOOD TRANSITION
K250	3 1/4" x 10" or equivalent	32.5"	N/A
Single (B100)	6" round or equivalent	28"	N/A
Dual (B200)	8" round or equivalent	50"	N/A
Dual (T200)	8" round or equivalent	50"	VP565 (Included)
Dual and Single (B200 & B100)	10" round or equivalent	79"	VP562 (Optional)
Two Dual (Two B200s)	12" round or equivalent	113"	VP563 (Optional)
Cluster (T400)	12" round or equivalent	113"	VP564 (Included)

DO NOT USE FLEXIBLE OR CORRUGATED DUCT. THIS TYPE OF DUCT WILL RESTRICT AIRFLOW AND REDUCE PERFORMANCE. ONLY USE SMOOTH, GALVANIZED, METAL DUCT. OBSERVE LOCAL CODES REGARDING SPECIAL DUCT REQUIREMENTS AND PLACEMENT OF DUCT AGAINST COMBUSTIBLES. MAKE THE DUCT RUN AS SHORT AND AS STRAIGHT AS POSSIBLE WITH AS FEW TURNS AS POSSIBLE. AVOID SHARP-ANGLED TURNS. INSTEAD, USE SMOOTH, GRADUAL TURNS SUCH AS ADJUSTABLE ELBOWS OR 45 DEGREE ANGLED TURNS. FOR DUCT RUNS OVER 20 FEET, INCREASE THE DUCT DIAMETER BY ONE INCH FOR EVERY TEN FEET OF DUCT. A 90 DEGREE ELBOW IS EQUAL TO 5 FEET OF DUCT. USING VENT-A-HOOD ROOF JACKS OR WALL LOUVERS WILL ENSURE PROPER EFFICIENCY. AIRFLOW MUST NOT BE RESTRICTED AT THE END OF THE DUCT RUN. DO NOT USE SCREEN WIRE OR SPRING-LOADED DOORS ON WALL LOUVERS OR ROOF JACKS. DO NOT TERMINATE VENTING INTO AN ATTIC OR CHIMNEY. WHERE POSSIBLE, SEAL JOINTS WITH DUCT TAPE. THE HOOD MUST BE DUCTED TO THE OUTDOORS WITHOUT RESTRICTIONS.

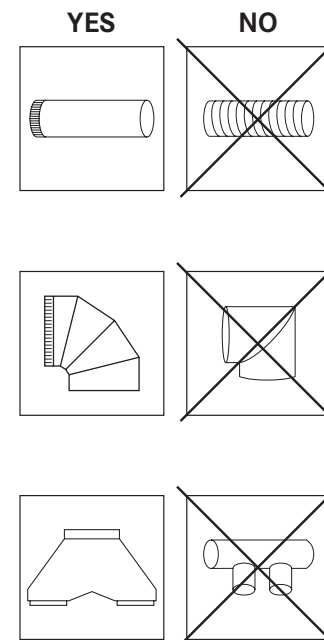

Vent Hood®

P.O. Box 830426
1000 N. GREENVILLE AVE.
RICHARDSON, TX 75083-0426
800-331-2492
WWW.VENTAHOOD.COM